



The power for your life

# UR12V-100AH

## Specifications

### Nominal Capacity

20 hour rate	( 5.36A to 10.20V)	107.2Ah
10 hour rate	( 9.16A to 10.20V)	91.6Ah
5 hour rate	( 16.1A to 10.20V)	80.5Ah
1 C	( 100A to 10.20V)	41Ah
3 C	( 300A to 10.20V)	25Ah

**Weight** Approx. 31.5KG

**Internal Resistance (at 1KHz)** Approx. 3.5 mΩ

**Maximum Discharge Current for 5 seconds:** 780 A

**Maximum Charging Current :** 19.5A

### Charging Methods at 25°C (77°F)

Cycle use:

Charging Voltage 14.4 to 15.0V

Coefficient -5.0mV/°C/cell

Standby use:

Float Charging Voltage 13.5 to 13.8V

Coefficient -3.0mV/°C/cell

### Operating Temperature Range

Charge -15°C(5°F) to 40°C(104°F)

Discharge -15°C(5°F) to 50°C(122°F)

Storage -15°C(5°F) to 40°C(104°F)

### Charge Retention (shef life) at 20°C (68°F)

1 month 92%

3 month 90%

6 month 80%

(Option: UL94 HB & UL94 V-0 flame retardant)

**Terminal** F4

**Life Time** 15Y

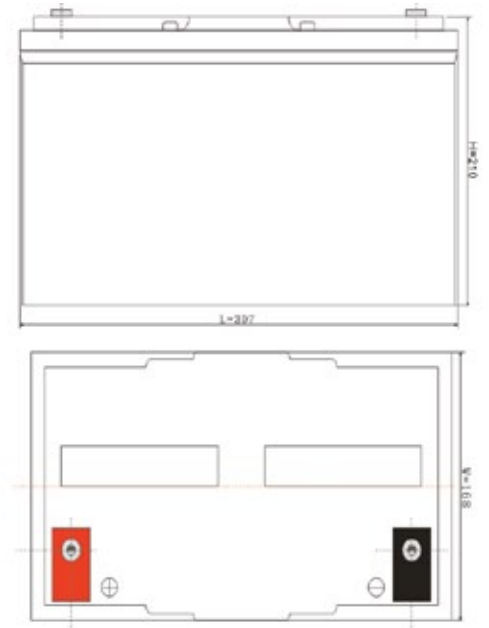
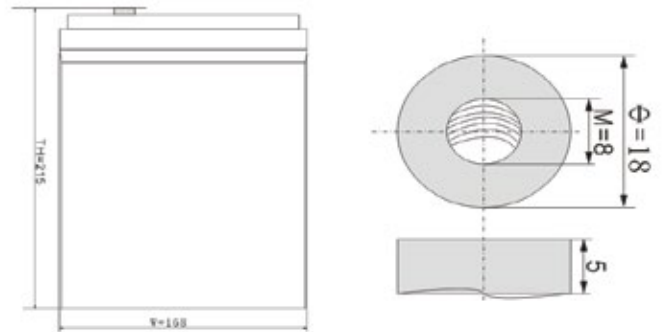

## Dimensions

Length:	307mm (12.05inch)
Width:	168mm (6.61inch)
Height:	210mm (8.26inch)
Overall Height:	215mm (8.46inch)



©2024 ultra. All rights reserved.

### Tickle(or Float) Service Life

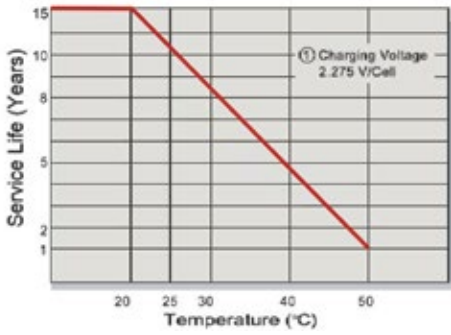

### Terminal Voltage (V) and Discharge Time

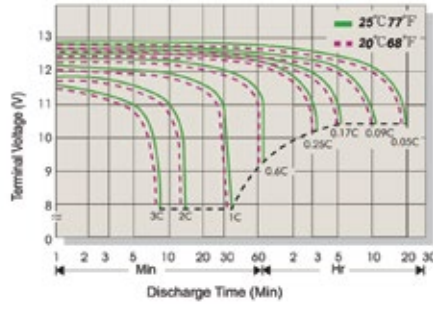

### Capacity Retention Characteristic

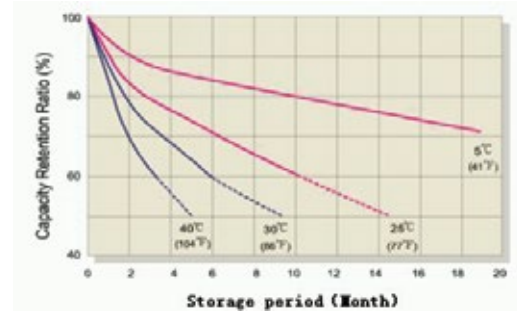

### Battery Voltage and Charge Time for Cycle Use

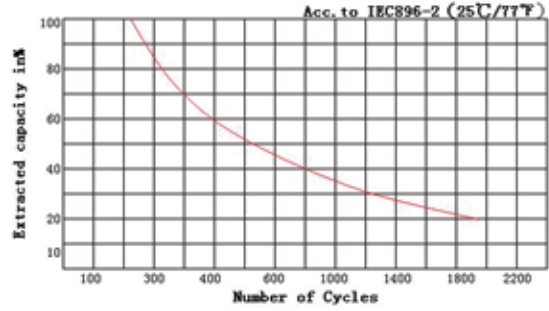
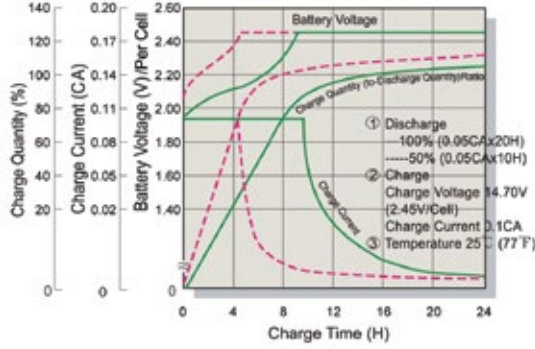

### Cycle Service Life

# PERFORMANCE DATA

### Discharge Rates in Watts to Various End Voltages at 25°C (77°F)

end voltage	5 min	10 min	15 min	30 min	45 min	1 h	2 h	3 h	4 h	5 h	6 h	8 h	10 h	20 h
9.6	3396	2538	2028	1260	918	726	407.4	291.6	229.8	191.4	164.4	131.4	109.2	65.4
9.9	3312	2490	2010	1248	912	720	405.6	290.4	229.2	190.8	163.8	130.8	109.2	64.2
10.02	3252	2466	1992	1242	906	720	405	289.2	228.6	190.8	163.8	130.2	108.6	63.9
10.2	3168	2436	1968	1236	900	714	403.8	288.6	228	190.2	163.2	130.2	108.6	63.6
10.5	3012	2334	1884	1212	888	714	402.6	286.8	226.8	189.6	162.6	129.6	108	63
10.8	2814	2196	1806	1182	876	702	399	283.8	223.8	186.6	160.2	128.4	107.4	62.4
11.1	2076	1710	1464	1014	768	624	359.4	259.8	205.8	172.2	147.6	117.6	98.4	59.22

### Discharge Rates in Amperes to Various End Voltages at 25°C(77°F)

end voltage	5 min	10 min	15 min	30 min	45 min	1 h	2 h	3 h	4 h	5 h	6 h	8 h	10 h	20 h
9.6	316	230	183	111	79.7	62.6	34.7	25.2	19.8	16.4	14	11.1	9.27	5.52
9.9	303	222	178	109	78.4	61.8	34.3	24.9	19.6	16.2	13.9	11.1	9.21	5.43
10.02	291	217	174	107	77.4	61.1	34.1	24.7	19.4	16.1	13.8	11	9.16	5.39
10.2	284	214	171	106	76.8	60.7	33.9	24.6	19.3	16.1	13.8	11	9.14	5.36
10.5	264	201	163	103	75	59.7	33.4	24.2	19.1	15.9	13.6	10.8	9.02	5.30
10.8	242	186	153	99.2	72.6	58	32.8	23.7	18.7	15.5	13.3	10.6	8.87	5.25
11.1	177	145	123	84.8	64.2	52	29.9	21.8	17.2	14.3	12.3	9.78	8.16	4.98

